

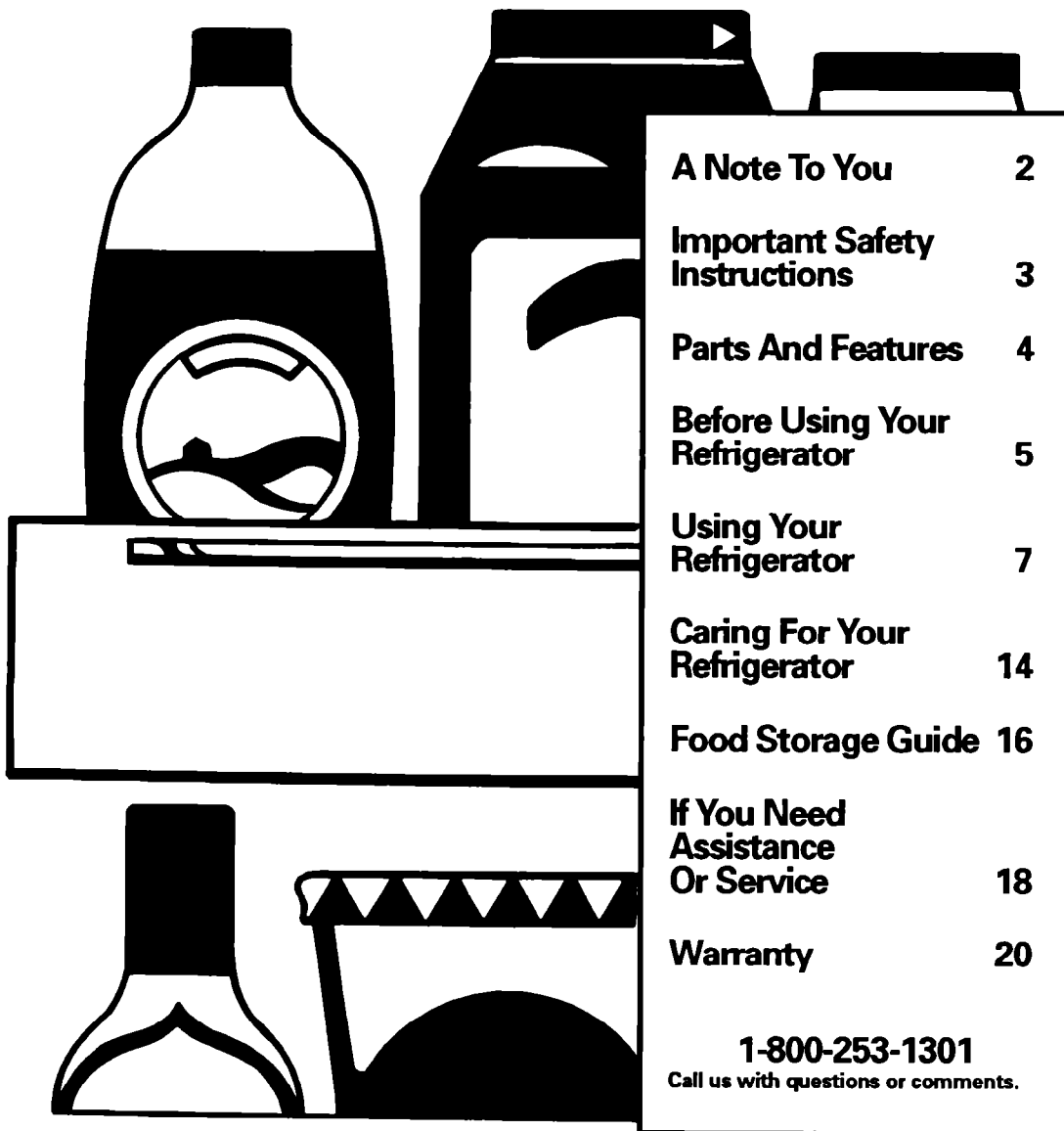

# Use And Care

## G U I D E



**NO-FROST REFRIGERATOR-FREEZER**

## A NOTE TO YOU

# A Note To You

### Thank you for buying a Whirlpool appliance.

You have purchased a quality, *world-class* home appliance. Years of engineering experience have gone into its manufacturing. To ensure that you will enjoy many years of trouble-free operation, we have developed this Use and Care Guide. It is full of valuable information on how to operate and maintain your appliance properly and safely. Please read it carefully. Also, please complete and mail the Ownership Registration Card provided with your appliance. This will help us notify you about any new information on your appliance.

### Your safety is important to us.

This guide contains safety symbols and statements. Please pay special attention to these symbols and follow any instructions given. Here is a brief explanation of the use of each symbol.

#### WARNING

This symbol will help alert you to such dangers as personal injury, burns, fire and electrical shock.

#### CAUTION

This symbol will help you avoid actions which could cause product damage (scratches, dents, etc.) and damage to your personal property.

### Our Consumer Assistance Center number, 1-800-253-1301, is toll-free, 24 hours a day.

If you ever have a question concerning your appliance's operation, or if you need service, first see "If You Need Assistance Or Service" on page 18. If you need further help, feel free to call our Consumer Assistance Center. When calling, you will need to know your appliance's complete model number and serial number. You can find this information on the model and serial number label (see diagram on page 4). For your convenience, we have included a handy place below for you to record these numbers, the purchase date from the sales slip and your dealer's name and telephone number. Keep this book and the sales slip together in a safe place for future reference.

Model Number \_\_\_\_\_

Dealer Name \_\_\_\_\_

Serial Number \_\_\_\_\_

Dealer Phone \_\_\_\_\_

Purchase Date \_\_\_\_\_

## IMPORTANT SAFETY INSTRUCTIONS

# Important Safety Instructions

### **WARNING**

To reduce the risk of fire, electrical shock, or injury when using your refrigerator, follow these basic precautions:

- Read all instructions before using the refrigerator.
- Child entrapment and suffocation are not problems of the past. Junked or abandoned refrigerators are still dangerous ... even if they will "just sit in the garage a few days."  
If you are getting rid of your old refrigerator, do it safely. Please read the enclosed safety booklet from the Association of Home Appliance Manufacturers. Help prevent accidents.
- Never allow children to operate, play with, or crawl inside the refrigerator.
- Never clean refrigerator parts with flammable fluids. The fumes can create a fire hazard or explosion.

• FOR YOUR SAFETY •

**DO NOT STORE OR USE GASOLINE OR OTHER FLAMMABLE VAPORS AND LIQUIDS IN THE VICINITY OF THIS OR ANY OTHER APPLIANCE. THE FUMES CAN CREATE A FIRE HAZARD OR EXPLOSION.**

– SAVE THESE INSTRUCTIONS –

### Help us help you

Please:

- Install and level the refrigerator on a floor that will hold the weight and in an area suitable for its size and use.
- Do not install the refrigerator near an oven, radiator or other heat source.
- Do not use the refrigerator in an area where the room temperature will fall below 55°F (13°C).
- Keep the refrigerator out of the weather.
- Connect the refrigerator only to the proper kind of outlet, with the correct electrical supply and grounding. (Refer to the Electrical Requirements and Grounding Instructions Sheet.)
- Do not load the refrigerator with food before it has time to get properly cold.
- Use the refrigerator only for the uses described in this manual.
- Properly maintain the refrigerator.
- Be sure the refrigerator is not used by anyone unable to operate it properly.

Also, remove tape and any inside labels (except the model and serial number label) before using the refrigerator.

#### To remove any remaining glue:

- Rub briskly with thumb to make a ball, then remove.
- OR
- Soak area with liquid hand dishwashing detergent before removing glue as described above. Do not use sharp instruments, rubbing alcohol, flammable fluids or abrasive cleaners. These can damage the material. See "Important Safety Instructions" above.

**NOTE:** Do not remove any permanent instruction labels inside your refrigerator. Do not remove the Tech Sheet fastened under the refrigerator at the front.

## PARTS AND FEATURES

# Parts And Features

This section contains captioned illustrations of your appliance. Use them to become familiar with where all parts and features are located and what they look like.

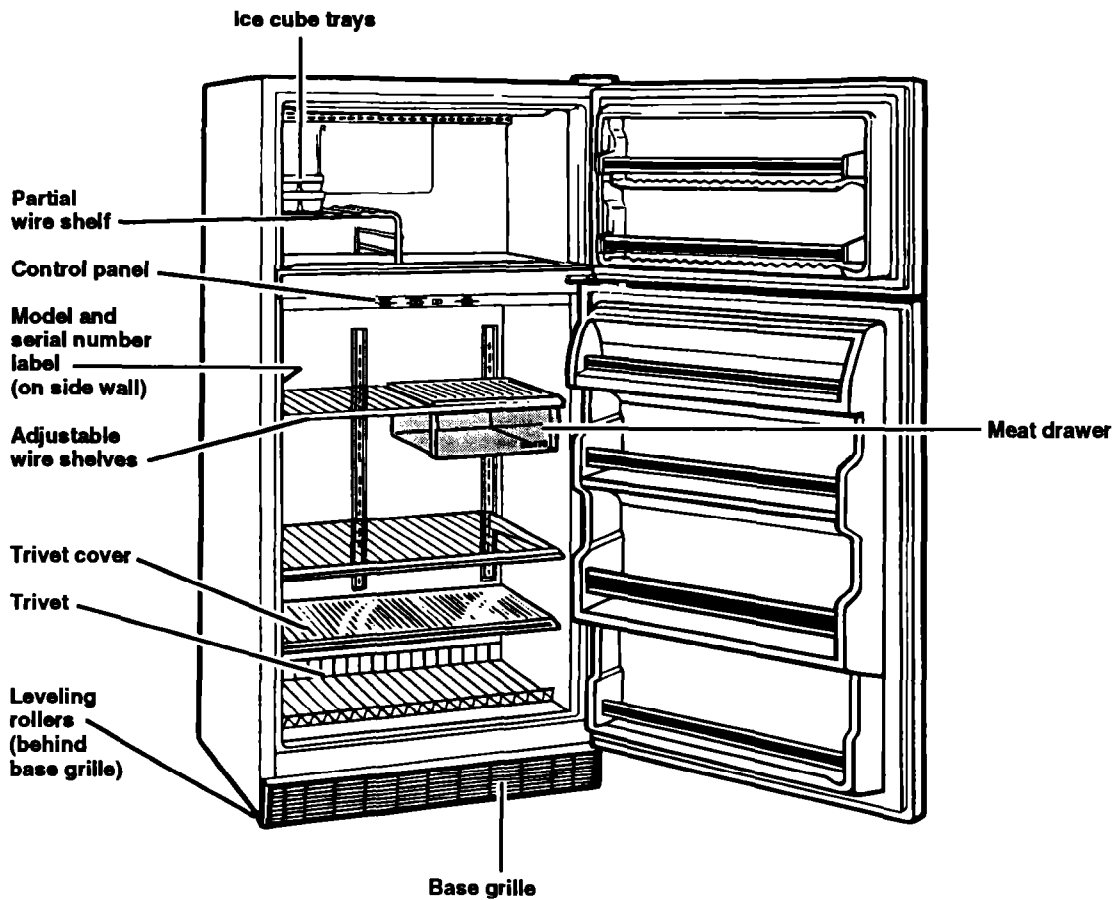

### Control panel

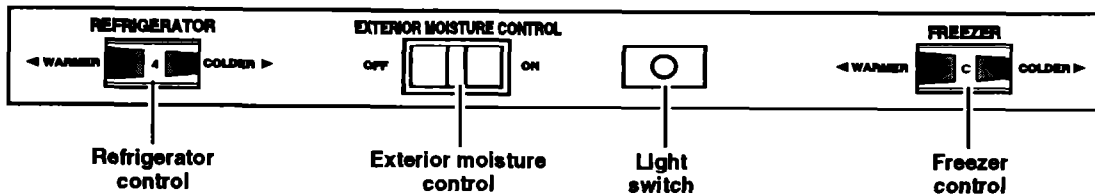

# Before Using Your Refrigerator

In This Section		Page	Page
Cleaning it .....	5	Installing it properly .....	5
Plugging it in .....	5	Leveling it .....	6

It is important to prepare your refrigerator for use. This section will tell you how to clean it, connect it to a power source, install it and level it.

## Cleaning it

Clean your refrigerator before using it, if necessary. See cleaning instructions on page 14.

## Plugging it in

### Recommended Grounding Method

A 115 Volt, 60 Hz., AC only 15 or 20 ampere fused and properly grounded electrical supply is required. It is recommended that a separate circuit serving only this appliance be provided. Use a receptacle which cannot be turned off with a switch or pull chain. Do not use an extension cord.

See Electrical Requirements and Grounding Instructions Sheet in your Literature Package.

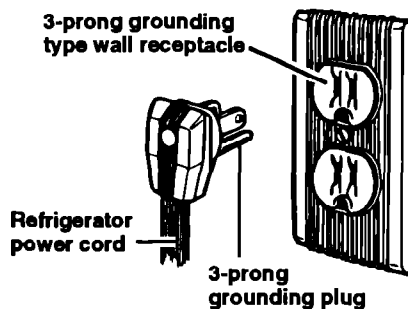

## Installing it properly

1. Allow ½ inch (1.25 cm) space on each side and at the top of the refrigerator for ease of installation.
2. If the hinge side of the refrigerator is to be against a wall, you might want to leave extra space so the door can be opened wider.
3. The refrigerator can be flush against the wall.

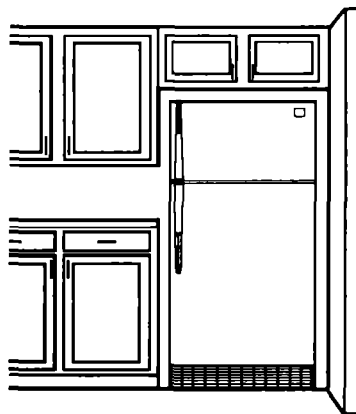

## BEFORE USING YOUR REFRIGERATOR

### Leveling it

Your refrigerator has 2 front leveling screws—one on the right and one on the left. To adjust one or both of these, follow the directions below.

1. Remove base grille. (See page 12.)
2. To raise front, turn screw clockwise.
3. To lower front, turn screw counterclockwise.
4. Check with level.
5. Replace base grille. (See page 12.)

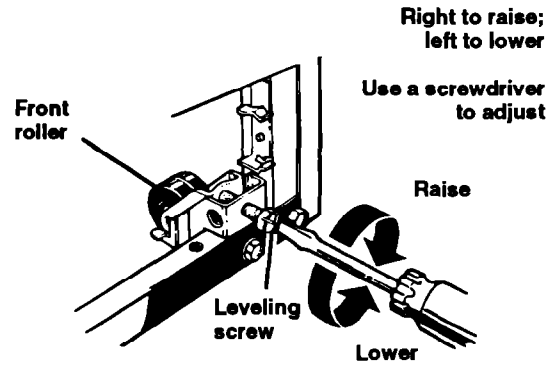

# Using Your Refrigerator

In This Section		Page	Page
Setting the controls .....	7	Using the optional automatic ice maker .....	11
Changing the control settings .....	8	Changing the light bulbs .....	12
Adjusting the refrigerator shelves .....	9	Removing the base grille .....	12
Removing the meat drawer and cover .....	9	Reversing the door swing .....	13
Removing the trivet and cover .....	10	Understanding the sounds you may hear ...	13
Using the ice cube trays .....	10	Saving energy .....	13

In order to obtain the best possible results from your refrigerator, it is important that you operate it properly. This section will tell you how to do just that.

## Setting the controls

### Temperature controls

Controls for the refrigerator and freezer are in the refrigerator. When the refrigerator is plugged in for the first time:

1. **Set the Refrigerator Control to 4.**  
Refrigerator Control adjustments range from 1 (warmest) to 8 (coldest).

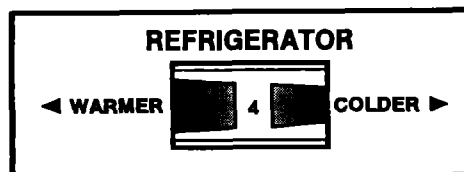

2. **Set the Freezer Control to C.**  
Freezer Control adjustments range from A (coldest) to D (warmest).
3. Give the refrigerator time to cool down completely before adding food. This may take several hours.

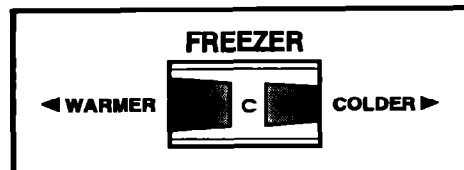

The settings indicated above should be correct for normal, household refrigerator usage. The controls will be set correctly when milk or juice is as cold as you like and when ice cream is firm. If you need to adjust these settings, see "Changing the control settings" on page 8.

### Exterior moisture control

The Exterior Moisture Control operates electric heaters around the door openings. These heaters help keep moisture from forming on the outside of the refrigerator cabinet.

1. Use the OFF setting when humidity is low.
2. Use the ON setting if moisture forms on the outside of the refrigerator cabinet.

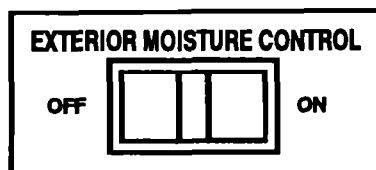

## USING YOUR REFRIGERATOR

### Changing the control settings

If you need to adjust temperatures in refrigerator or freezer, use the settings listed in the chart below as a guide. If you have questions, call our Consumer Assistance Center number. (See page 19.)

- Adjust the Refrigerator Control first.
- Wait at least 24 hours between adjustments.
- Then adjust the Freezer Control if needed.

CONDITION:	REASON:	RECOMMENDED CONTROL SETTINGS:	
If Refrigerator Section is TOO WARM	Door opened often Large amount of food added Room temperature too warm	Refrigerator Freezer	6 D
If Freezer Section is TOO WARM	Door opened often Large amount of food added Very cold room temperature (can't cycle often enough)	Refrigerator Freezer	4 A
If Refrigerator Section is TOO COLD	Controls not set correctly for your conditions	Refrigerator Freezer	2 A
If ICE isn't MADE FAST ENOUGH	Heavy ice usage Very cold room temperature (can't cycle often enough)	Refrigerator Freezer	4 A
If BOTH SECTIONS are TOO WARM	Door opened often Large amount of food added Very warm or very cold room temperatures	Refrigerator Freezer	6 C

---

## **Adjusting the refrigerator shelves**

Shelves can be adjusted to match the way you use your refrigerator.

### **To remove shelves:**

1. Remove items from shelf.
2. Tilt shelf up at front.
3. Lift back of shelf.
4. Pull shelf straight out.

### **To replace shelves:**

1. Guide the rear shelf hooks into the slots in the shelf supports on cabinet wall.
2. Tilt shelf up at front until hooks drop into slots. Lower front of shelf to level position.

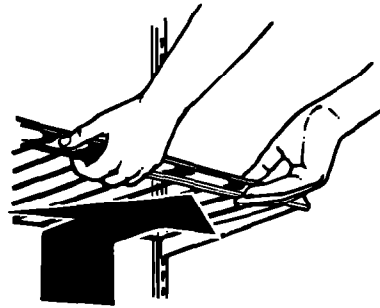

---

## **Removing the meat drawer and cover**

The meat drawer and cover can be removed for cleaning or moved to another shelf, if desired. Remove the meat drawer first.

### **To remove the meat drawer:**

1. Slide the drawer straight out to the stop.
2. Lift the front.
3. Slide drawer out the rest of the way.
4. Replace in reverse order.

### **To remove the cover:**

1. Remove the meat drawer.
2. Tilt front of cover up.
3. Pull cover up and out.

### **To replace the cover:**

1. Fit bottom notches of cover over rear and center cross bars of shelf.
2. Lower cover into place.
3. Replace the meat drawer.

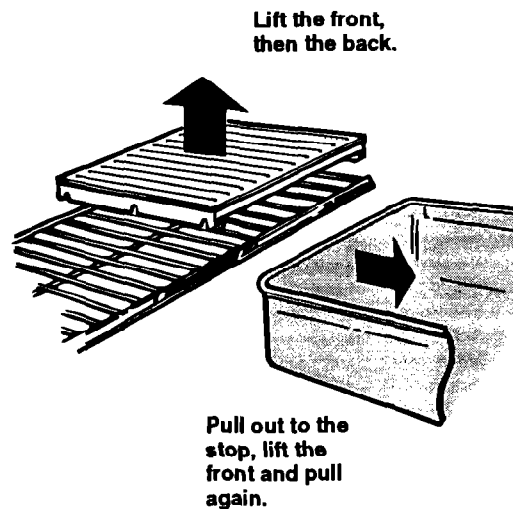

## USING YOUR REFRIGERATOR

---

### Removing the trivet and cover

The trivet can be removed for easier cleaning.

**To remove the trivet:**

1. Lift trivet up and out.
2. Replace trivet with higher edge toward the rear of the refrigerator.

Lift trivet up  
and out.

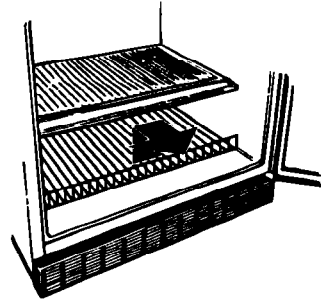

**To remove the cover:**

1. Lift front of cover.
2. Lift cover up and out.

**To replace the cover:**

1. Fit cover notches into supports on walls of refrigerator cabinet.
2. Lower the front into place.

Lift the front,  
then the back.

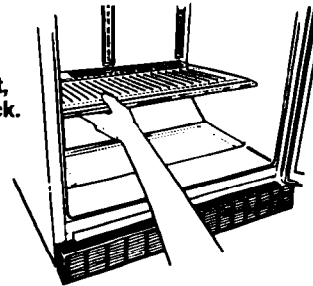

---

### Using the ice cube trays

If cubes are not used, they may shrink. The moving cold air starts a slow evaporation. The longer cubes are stored, the smaller they get.

**To remove ice:**

1. Hold tray at both ends.
2. Twist slightly.

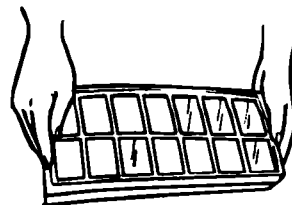

## Using the optional automatic ice maker

If you plan to add an automatic ice maker later (Part No. ECKMF-90), there are a few things you will want to know:

- The ON/OFF lever is a wire signal arm.  
Down ... to make ice automatically.  
Up ... to shut off the ice maker.

**NOTE: Do not turn ice maker on until it is connected to the water supply. Instructions for ice maker water supply hook up are attached to the back of the refrigerator cabinet.**

- The dial or lever on the side of the ice maker changes the size of the cubes.
- Shake the bin occasionally to keep cubes separated and to obtain increased storage capacity.
- It is normal for ice crescents to be attached by a corner. They will break apart easily.
- You will hear water running when ice maker is working. You'll hear ice fall into the bin. Don't let these sounds bother you.
- The ice maker will not operate until the freezer is cold enough to make ice. This can take overnight.
- Because of new plumbing connections, the first ice may be discolored or off-flavored. Discard the first few batches of ice.
- If ice is not being made fast enough and more ice is needed, turn the Refrigerator Control toward a higher number. Wait a day and, if necessary, turn the Freezer Control toward A.
- If you remove the ice bin, raise the signal arm to shut off the ice maker. When you return the bin, push it in all the way and lower the signal arm to the ON position.
- If cubes are stored too long, they may develop an off-flavor ... like stale water. Throw them away. Ice maker will make new ice. Cubes in the ice bin can also become smaller by evaporation.
- Good water quality is important for good ice quality. It is not recommended that the ice maker be connected to a softened water supply. Water softener chemicals, such as salt from a malfunctioning softener, can damage the ice maker mold and lead to poor ice quality. If a softened water supply cannot be avoided, it is important that the water softener be well maintained and operating properly.

Raise signal arm to stop ice.

Lower signal arm to start it.

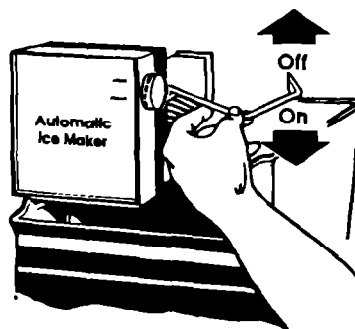

## Changing the light bulbs

### **⚠ WARNING**

#### **Electrical Shock Hazard**

Before removing a light bulb, either unplug the refrigerator or disconnect the electricity leading to the refrigerator at the main power supply.

Failure to do so could result in electrical shock or personal injury.

#### **To change the refrigerator light:**

1. Disconnect refrigerator from power supply.
2. Reach behind the Control Panel to remove bulb.
3. Replace with a 40-watt appliance bulb.
4. Reconnect refrigerator to power supply.

**NOTE:** Not all commercial appliance bulbs will fit your refrigerator. Be sure to replace a bulb with one of the same size and shape.

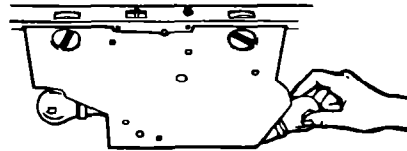

## Removing the base grille

#### **To remove the grille:**

1. Open refrigerator door.
2. Pull base grille forward to release the support tabs from the metal clips.
3. Do not remove Tech Sheet fastened behind the grille.

#### **To replace the grille:**

1. Line up grille support tabs with metal clips.
2. Push firmly to snap into place.
3. Close refrigerator door.

See cleaning instructions for defrost pan and condenser coils on page 15.

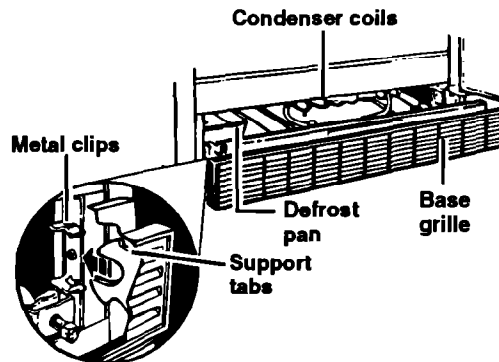

---

### Reversing the door swing

You can change the hinges on your refrigerator so the doors open the other way. Refer to the instruction sheet included with your refrigerator.

---

### Understanding the sounds you may hear

Your new refrigerator may make sounds that your old one didn't. Because the sounds are new to you, you might be concerned about them. Don't be. Most of the new sounds are normal. Hard surfaces like the floor, walls and cabinets can make the sounds seem louder.

The following describes the kinds of sounds that might be new to you, and what may be making them.

#### Slight hum, soft hiss

You may hear the refrigerator's fan motor and moving air.

#### Clicking or snapping sounds

The thermostat makes a definite click when the refrigerator stops running. It also makes a sound when the refrigerator starts. The defrost timer will click when the defrost cycle starts.

#### Water sounds

When the refrigerator stops running, you may hear gurgling in the tubing for a few minutes after it stops. You may also hear defrost water running into the defrost water pan.

#### Ice maker sounds

- trickling water
- thud (clatter of ice)

If your refrigerator has an ice maker, you may hear buzzing (from the water valve), trickling water and the clatter of ice dumped into the bin.

#### Running sounds

Your refrigerator has a high-efficiency compressor and motor. It will run longer than older designs. It may even seem to run most of the time.

---

### Saving energy

You can help your refrigerator use less electricity.

- Check door gaskets for a tight seal. Level the cabinet to be sure of a good seal.
- Clean the condenser coils regularly.
- Open the door as few times as possible. Think about what you need before you open the door. Get everything out at one time. Keep food organized so you won't have to search for what you want. Close door as soon as food is removed.
- Go ahead and fill up the refrigerator, but don't overcrowd it so air movement is blocked.
- It is a waste of electricity to set the refrigerator and freezer to temperatures colder than they need to be. If ice cream is firm in the freezer and drinks are as cold as your family likes them, that's cold enough.
- Make sure your refrigerator is not next to a heat source such as a range, water heater, furnace, radiator or in direct sunlight.

# Caring For Your Refrigerator

In This Section		Page	Page
Cleaning your refrigerator .....	14	Power interruptions .....	16
Vacation and moving care .....	15		

Your refrigerator is built to give you many years of dependable service. However, there are a few things you can do to help extend its product life. This section will tell you how to clean your refrigerator and what to do when going on vacation, moving or during a power outage.

## Cleaning your refrigerator

Both the refrigerator and freezer sections defrost automatically. But both should be cleaned about once a month to help prevent odors from building up. Spills should be wiped up right away.

To clean your refrigerator, turn the Refrigerator Control to OFF, unplug it, take out all removable parts and clean the refrigerator according to the following directions.

**⚠ WARNING**

**Personal Injury Hazard**

Refrigeration system tubes are located near the defrost pan and can become hot. Remove and install defrost pan carefully. Failure to do so could result in personal injury.

PART	WHAT TO USE	HOW TO CLEAN
<b>Removable parts</b> (shelves, etc.)	Sponge or cloth with mild detergent and warm water	<ul style="list-style-type: none"> <li>• Hand wash, rinse and dry thoroughly.</li> </ul>
<b>Outside</b>	Sponge, cloth or paper towel with mild detergent, warm water and an appliance wax (or good auto paste wax)	<ul style="list-style-type: none"> <li>• Wash outside of cabinet. Do not use abrasive or harsh cleaners.</li> <li>• Rinse and dry thoroughly.</li> <li>• Wax painted metal surfaces at least twice a year. Apply wax with a clean, soft cloth. <b>Waxing painted metal surfaces provides rust protection. Do not wax plastic parts.</b></li> </ul>
<b>Inside walls</b> (freezer should be allowed to warm up so cloth won't stick)	Sponge, soft cloth or paper towel with baking soda or mild detergent and warm water	<ul style="list-style-type: none"> <li>• Wash with mixture of warm water and – mild detergent, or – baking soda (2 tablespoons [26 g] to 1 quart [.95 L] of water).</li> <li>• Rinse and dry thoroughly.</li> </ul>
<b>Door liners and gaskets</b>	Sponge, soft cloth or paper towel with mild detergent and warm water	<ul style="list-style-type: none"> <li>• Wash, rinse and dry thoroughly.</li> </ul> <p><b>DO NOT USE cleaning waxes, concentrated detergents, bleaches or cleaners containing petroleum on plastic parts.</b></p>
<b>Plastic parts</b> (covers and panels)	Soft, clean sponge or soft, clean cloth with mild detergent and warm water	<ul style="list-style-type: none"> <li>• Wash, rinse and dry thoroughly.</li> </ul> <p><b>DO NOT USE paper towels, window sprays, scouring cleansers or flammable fluids. These can scratch or damage material. See "Important Safety Instructions" on page 3.</b></p>

## CARING FOR YOUR REFRIGERATOR

PART	WHAT TO USE	HOW TO CLEAN
<b>Defrost pan</b>	Sponge or cloth with mild detergent and warm water	<ul style="list-style-type: none"> <li>• Remove base grille. (See page 12.)</li> <li>• To remove defrost pan, lift pan over wire brace (remove tape; if any).</li> <li>• Wash, rinse and dry thoroughly.</li> <li>• Replace with notched corner to the rear. Push it in all the way.</li> <li>• Make sure defrost pan drain tube is pointing into pan.</li> <li>• Replace base grille.</li> </ul>
<b>Condenser coils</b>	Vacuum cleaner with extended narrow attachment	<ul style="list-style-type: none"> <li>• Remove base grille.</li> <li>• Vacuum coils when dusty or dirty. Coils may need to be cleaned as often as every other month.</li> <li>• Replace base grille.</li> </ul>
<b>Floor under refrigerator</b>	Floor cleaners	<ul style="list-style-type: none"> <li>• Roll refrigerator out only as far as the water supply line allows.</li> <li>• Clean floor.</li> <li>• Roll refrigerator back into place.</li> <li>• Check to see if the refrigerator is level.</li> </ul>

## Vacation and moving care

### Long vacations

Remove all the food if you are going for a month or more. If your refrigerator is equipped with an automatic ice maker, turn off the water supply to the ice maker at least one day ahead. When the last load of ice drops, turn off the ice maker. Make sure all ice is dispensed out of mechanism.

Unplug the refrigerator. Clean it, rinse well and dry. Tape rubber or wood blocks to the tops of both doors to prop them open far enough for air to get in. This will keep odor and mold from building up.

### ⚠ WARNING

#### Personal Injury Hazard

Do not allow children to climb on, play near or climb inside the refrigerator when the doors are blocked open. They may become injured or trapped.

To restart refrigerator, see "Using Your Refrigerator" on page 7.

### Short vacations

No need to shut off the refrigerator if you will be away for less than four weeks. Use up perishables; freeze other items. If you have an automatic ice maker:

1. Turn off your ice maker by raising signal arm.
2. Shut off the water supply to the ice maker.
3. Empty the ice bin.

### Moving

If your refrigerator is equipped with an automatic ice maker, shut off the ice maker water supply at least a day ahead. Disconnect the water line. After the last load of ice drops, lift the signal arm to turn off the ice maker.

Remove all food. Pack frozen food in dry ice. Unplug the refrigerator and clean it thoroughly.

Take out all removable parts. Wrap all parts well and tape them together so they don't shift and rattle. Screw in the leveling legs; tape the doors shut; and tape the electric cord to the cabinet.

When you get to your new home, put everything back and refer to page 5. Also, if you have an automatic ice maker, remember to reconnect the water supply line.

# CARING FOR YOUR REFRIGERATOR

## Power interruptions

If electricity goes off, call the power company. Ask how long power will be off.

1. If service is to be interrupted 24 hours or less, **keep both doors closed**. This will help foods stay frozen.
2. If service is to be interrupted longer than 24 hours:
  - (a) Remove all frozen food and store in a frozen food locker.

OR

  - (b) Place 2 lbs. (0.9 kg) of dry ice in freezer for every cubic foot of freezer space. This will keep food frozen for 2 to 4 days. Wear gloves to protect your hands from dry ice burns.

OR

  - (c) If neither a food locker or dry ice is available, use or can perishable food at once.

3. A full freezer will stay cold longer than a partly filled one. A freezer full of meat will stay cold longer than a freezer full of baked goods. If food contains ice crystals, it may be safely refrozen, although the quality and flavor may be affected. If the condition of the food is poor or if you feel it is unsafe, dispose of it.

## Questions ?

Call our Consumer Assistance Center telephone number, 1-800-253-1301.

# Food Storage Guide

In This Section		Page	Page
Storing fresh food .....	16	Storing frozen food .....	17

There is a correct way to package and store refrigerated or frozen food. To keep food fresher, longer, take the time to study these recommended steps.

## Storing fresh food

Food placed in the refrigerator should be wrapped or stored in air and moisture proof material. This prevents food odor and taste transfer throughout the refrigerator. For dated products, check code date to ensure freshness.

### Leafy vegetables

Remove store wrapping and trim or tear off bruised and discolored areas. Wash in cold water and drain. Place in plastic bag or plastic container and store in crisper.

### Vegetables with skins (carrots, peppers)

Store in crisper, plastic bags or plastic container.

### Fruit

Wash, let dry and store in refrigerator in plastic bags or crisper. Do not wash or hull berries until they are ready to use. Sort and keep berries in their store container in a crisper, or store in a loosely closed paper bag on a refrigerator shelf.

### Eggs

Store without washing in the original carton on interior shelf.

### Milk

Wipe milk cartons. For best storage, place milk on interior shelf.

## Butter or margarine

Keep opened butter in covered dish or closed compartment. When storing an extra supply, wrap in freezer packaging and freeze.

## Cheese

Store in the original wrapping until you are ready to use it. Once opened, rewrap tightly in plastic wrap or aluminum foil.

## Leftovers

Cover leftovers with plastic wrap or aluminum foil. Plastic containers with tight lids can also be used.

## Meat

Most meat can be stored in original wrapping as long as it is air and moisture proof. Rewrap if necessary. See the following chart for storage times.

TYPE	APPROXIMATE TIME (DAYS)*
Chicken	1 to 2
Ground beef	1 to 2
Steaks and roasts	3 to 5
Cured meats	7 to 10
Bacon	5 to 7
Cold cuts	3 to 5
Variety meats	1 to 2

\*If meat is to be stored longer than the times given, follow the directions for freezing.

**NOTE:** Fresh fish and shellfish should be used the same day as purchased.

## Storing frozen food

The freezer section is designed for storage of commercially frozen food and for freezing food at home.

**NOTE:** For further information about preparing food for freezing or food storage times, contact your local Cooperative Extension Service or check a freezer guide or a reliable cookbook.

### Packaging

The secret of successful freezing is in the packaging. The way you close and seal the package must not allow air or moisture in or out. Packaging done in any other way could cause food odor and taste transfer throughout the refrigerator and drying of frozen food.

#### Recommended packaging for freezing:

- Rigid polyethylene (plastic) containers with tight-fitting lids
- Straight-sided canning/freezing jars
- Heavy-duty aluminum foil
- Plastic-coated paper
- Non-permeable plastic wraps (made from a saran film)

Follow package or container instructions for proper freezing methods.

#### Do not use:

- Bread wrappers
- Non-polyethylene plastic containers
- Containers without tight lids
- Waxed paper
- Waxed-coated freezer wrap
- Thin, semi-permeable wrap

The use of these wrappings could cause food odor, taste transfer and drying of frozen food.

### Freezing

Do not expect your freezer to quick-freeze any large quantity of food. Put no more unfrozen food into the freezer than will freeze within 24 hours. (No more than 2 to 3 pounds of food per cubic foot of freezer space.) Leave enough space for air to circulate around packages. Be careful to leave enough room at the front so the door can close tightly.

Storage times will vary according to the quality of the food, the type of packaging or wrap used (air and moisture proof) and the storage temperature (which should be 0°F [-17.8°C]).

# If You Need Assistance Or Service

This section is designed to help you save the cost of a service call. Part 1 of this section outlines possible problems, their causes, and actions you can take to solve each problem. Parts 2 and 3 tell you what to do if you still need assistance or service. When calling our Consumer Assistance Center for help or calling for service, please provide a detailed description of the problem, your appliance's complete model and serial numbers and the purchase date. (See page 2.) This information will help us respond properly to your request.

## 1. Before calling for assistance ...

Performance problems often result from little things you can find and fix without tools of any kind. Please check the chart below for problems you can fix. It could save you the cost of a service call.

<b>PROBLEM</b>	<b>POSSIBLE CAUSE</b>	<b>SOLUTION</b>
<b>Your refrigerator will not operate</b>	The power supply cord is not plugged into a live circuit with proper voltage. A household fuse has blown or circuit breaker tripped. The Refrigerator Control is not set correctly.	Firmly plug power cord into a live circuit with proper voltage. (See page 5.) Replace household fuse or reset circuit breaker. Set Refrigerator Control to a numbered setting. (See page 7.)
<b>Unfamiliar sounds or a rattling/jingling noise</b>	There is something on top of or behind the refrigerator. The sounds are normal.	Remove item from on top of or behind the refrigerator. New features on your new refrigerator make new sounds. (See "Understanding the sounds you may hear" on page 13.)
<b>There is water in the defrost pan</b>	This is normal in hot, muggy weather. The pan may even be half full.	Make sure the refrigerator is level so the pan does not overflow.
<b>The lights do not work</b>	A household fuse has blown or circuit breaker tripped. The power supply cord is not plugged into a live circuit with proper voltage. The bulb is burned out.	Replace household fuse or reset circuit breaker. Firmly plug power cord into a live circuit with proper voltage. (See page 5.) Replace bulb. (See page 12.)
<b>The optional ice maker will not operate</b>	The freezer has not had enough time to get cold. The signal arm is in the OFF (up) position. The water valve is turned off. Water is not getting to the ice maker.	Allow the freezer time to get cold—this could take overnight. Push signal arm down to the ON position. (See page 11.) Turn the water valve on. Check the water line for clogs or leaks.
<b>The motor seems to run too much</b>	The condenser coils are dirty. It is hot outside or in the room. The door has been opened frequently. A large amount of food has been put in at one time.	Clean the coils (See page 15.) On hot days, or if the room is too warm, the motor naturally runs longer. Open the door as few times as possible. The motor will run longer in order to cool down the interior when food is added.

## IF YOU NEED ASSISTANCE OR SERVICE

### Remember:

Motor running time depends on different things: number of door openings, amount of food stored, temperature of the room, setting of controls, etc.

Your new refrigerator may be larger than your old one so it has more space to be cooled. It also has a regular freezer instead of a frozen food compartment. All this means better refrigeration and may require more running time than your old one.

### 2. If you need assistance ...

Call Whirlpool Consumer Assistance Center telephone number. Dial free from anywhere in the U.S.:

1-800-253-1301

and talk with one of our trained consultants. The consultant can instruct you in how to obtain satisfactory operation from your appliance or, if service is necessary, recommend a qualified service company in your area.

If you prefer, write to:

Mr. William Clark  
Consumer Assistance Representative  
Whirlpool Corporation  
2000 M-63  
Benton Harbor, MI 49022

Please include a daytime phone number in your correspondence.

### 3. If you need service ...



Whirlpool has a nationwide network of authorized Whirlpool<sup>SM</sup> service companies. Whirlpool service technicians are trained to

fulfill the product warranty and provide after-warranty service, anywhere in the United States. To locate the authorized Whirlpool service company in your area, call our Consumer Assistance Center telephone number (see Step 2) or look in your telephone directory Yellow Pages under:

#### • APPLIANCE-HOUSEHOLD-MAJOR, SERVICE & REPAIR

- See: Whirlpool Appliances or Authorized Whirlpool Service  
(Example: XYZ Service Co.)

#### • WASHING MACHINES & DRYERS, SERVICE & REPAIR

- See: Whirlpool Appliances or Authorized Whirlpool Service  
(Example: XYZ Service Co.)

### 4. If you need FSP® replacement parts ...

FSP is a registered trademark of Whirlpool Corporation for quality parts. Look for this symbol of quality whenever you need a replacement part for your Whirlpool appliance. FSP replacement parts will fit right and work right, because they are made to the same exacting specifications used to build every new Whirlpool appliance.

To locate FSP replacement parts in your area, refer to Step 3 above or call the Whirlpool Consumer Assistance Center number in Step 2.

### 5. If you are not satisfied with how the problem was solved ...

- Contact the Major Appliance Consumer Action Panel (MACAP). MACAP is a group of independent consumer experts that voices consumer views at the highest levels of the major appliance industry.
- Contact MACAP only when the dealer, authorized servicer and Whirlpool have failed to resolve your problem.  
Major Appliance Consumer Action Panel  
20 North Wacker Drive  
Chicago, IL 60606
- MACAP will in turn inform us of your action.

# WHIRLPOOL®

## Refrigerator Warranty

LENGTH OF WARRANTY	WHIRLPOOL WILL PAY FOR
<b>FULL ONE-YEAR WARRANTY</b> From Date of Purchase	FSP® replacement parts and repair labor to correct defects in materials or workmanship. Service must be provided by an authorized Whirlpool <sup>SM</sup> service company.
<b>FULL FIVE-YEAR WARRANTY</b> From Date of Purchase	FSP replacement parts and repair labor to correct defects in materials or workmanship in the sealed refrigeration system. These parts are: <ol style="list-style-type: none"> <li>1. Compressor</li> <li>2. Evaporator</li> <li>3. Condenser</li> <li>4. Drier</li> <li>5. Connecting tubing</li> </ol> Service must be provided by an authorized Whirlpool <sup>SM</sup> service company.
WHIRLPOOL WILL NOT PAY FOR	
<b>A. Service calls to:</b> <ol style="list-style-type: none"> <li>1. Correct the installation of the refrigerator.</li> <li>2. Instruct you how to use the refrigerator.</li> <li>3. Replace house fuses or correct house wiring or plumbing.</li> <li>4. Replace light bulbs.</li> </ol> <b>B. Repairs when refrigerator is used in other than normal, single-family household use.</b> <b>C. Pickup and delivery.</b> This product is designed to be repaired in the home. <b>D. Damage to refrigerator caused by accident, misuse, fire, flood, acts of God or use of products not approved by Whirlpool.</b> <b>E. Any food loss due to product failure.</b> <b>F. Repairs to parts or systems caused by unauthorized modifications made to the appliance.</b>	

8-92

WHIRLPOOL CORPORATION SHALL NOT BE LIABLE FOR INCIDENTAL OR CONSEQUENTIAL DAMAGES. Some states do not allow the exclusion or limitation of incidental or consequential damages, so this limitation or exclusion may not apply to you. This warranty gives you specific legal rights, and you may also have other rights which vary from state to state.

Outside the United States, a different warranty may apply. For details, please contact your authorized Whirlpool distributor or military exchange.

If you need service, first see the "Assistance or Service" section of this book. After checking "Assistance or Service," additional help can be found by calling our Consumer Assistance Center telephone number, 1-800-253-1301, from anywhere in the U.S.